

True Flame Detection Technology

# MICROPACK

MICROPACK (Engineering) Ltd.  
 Fire Training Centre, Schoolhill, Portlethen, Aberdeen, AB12 4RR  
 Tel: +441224 784 055 Fax: +441224 784056  
 Web: www.micropack.co.uk

## VTP4 - Balanced Line To BNC VIDEO CONVERTER TECHNICAL MANUAL - Ref: 2200.5005



Rev.	Date	ECN	Prepared	Checked	Approved
3.0	04 May 2009	360	D. Barclay	E. Campion	T. McGuire

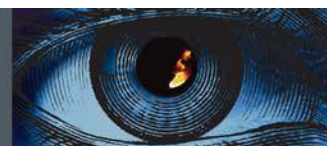



<b>VTP4 – Balanced Line To BNC Video Converter</b>		
<b>Ref 2200.5005</b>	<b>Rev: 3.0</b>	<b>Page 2 of 15</b>

## HELP US TO HELP YOU

Every effort has been made to ensure the accuracy in the contents of our documents; however, Micropack (Engineering) Ltd can assume no responsibility for any errors or omissions in our documents or their consequences.

Micropack (Engineering) Ltd would greatly appreciate being informed of any errors or omissions that may be found in our documents. To this end we include a form, given in Appendix A, for you to photocopy, complete and return to us so that we take the appropriate action. Thank you.

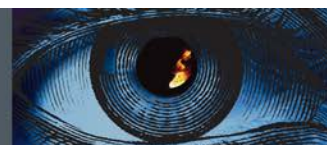



<b>VTP4 – Balanced Line To BNC Video Converter</b>		
<b>Ref 2200.5005</b>	<b>Rev: 3.0</b>	<b>Page 3 of 15</b>

## Table of Contents

1	Introduction .....	4
1.1	Overview .....	4
1.2	Coaxial Video outputs .....	4
1.3	Led Indications .....	4
1.4	Balanced Line Video Input .....	5
2	Safety Instructions .....	6
2.1	Warnings .....	6
2.2	Cautions .....	6
2.3	Important Safety Notices .....	6
3	Installation .....	7
3.1	VTP4 Mounting .....	7
3.2	Mechanical Installation .....	8
3.3	Field Terminations .....	8
3.4	Electrical Installation .....	9
4	Maintenance and Testing .....	9
5	System Design Guidelines .....	10
5.1	Power Supply .....	10
5.2	Balanced Line Video (twisted pair) Input .....	10
5.3	Video (Coaxial) Output .....	10
5.4	Earthing & Screening Requirements .....	10
5.5	Coaxial Video Cable Selection .....	11
5.6	Balanced Line Video (Twisted Pair) Cable Selection .....	11
6	Fault Finding .....	12
6.1	Live Video Images .....	12
6.2	Replacement and Repair .....	12
7	Technical Specification .....	13
7.1	Electrical Specification .....	13
7.2	Mechanical Specification .....	13
7.3	Environmental Specification .....	13
7.4	Certification and Approvals .....	14
	Appendix A – Help us to help you .....	15

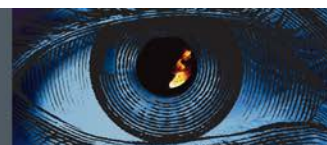



<b>VTP4 – Balanced Line To BNC Video Converter</b>		
<b>Ref 2200.5005</b>	<b>Rev: 3.0</b>	<b>Page 4 of 15</b>

# 1 Introduction

The Micropack Balanced Line to BNC Video Converter (VTP4 p/n 3100.0010) is used to convert between Micropack's Video System twisted pair video cabling (balanced line) and standard 75R coaxial cabling (BNC) found in commercial video equipment.

The converter has four independent channels. The converter is powered from an industrial standard 24V supply. The converter has been designed specifically to meet the needs of an industrial application.

## 1.1 Overview

The converter is a single board measuring 100 Length x 70 width (mm). With DIN Rail Mounting Connection to equipment is via standard BNC female connectors. Connection to the video system twisted pair cabling is via screw terminals. The key elements of the converter are shown below:

Figure 1 Converter Overview

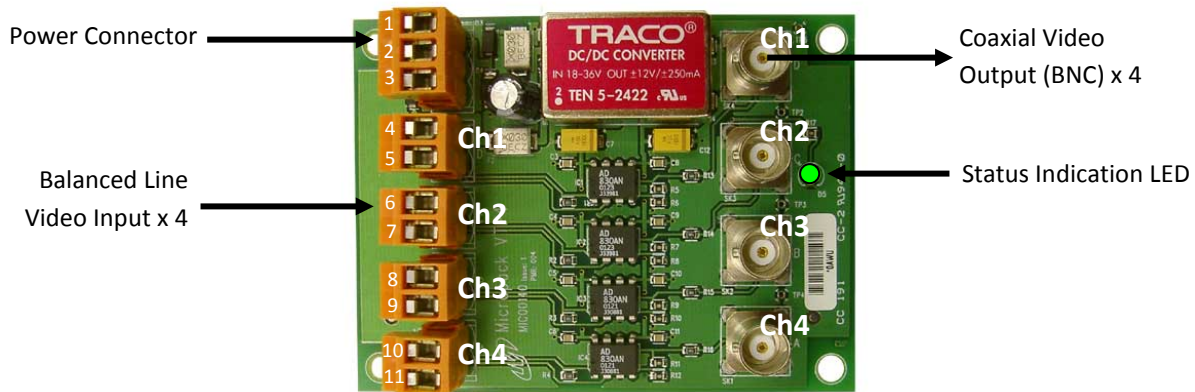

## 1.2 Coaxial Video outputs

The converters four BNC outputs each support standard 75R coaxial video cabling.

## 1.3 Led Indications

The LED indicator is used to reveal its current state, as shown below:

Table 1 LED Status Diagnostic Chart

Green LED	Device Condition	Comment
ON	Healthy - Data Transmission in progress	OK
OFF	Power Failed	Check power distribution

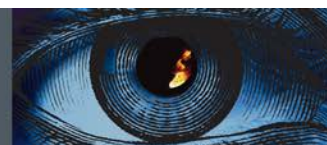



<b>VTP4 – Balanced Line To BNC Video Converter</b>		
<b>Ref 2200.5005</b>	<b>Rev: 3.0</b>	<b>Page 5 of 15</b>

## 1.4 Balanced Line Video Input

The converters' four inputs each support balanced line video using a simple twisted pair cable, note the converter is a balanced line receiver and a coaxial driver. Between two and six balanced line video devices can be connected to a single transmission line with no spurs or loops. The connection of balanced line video is very similar to RS485 communications as shown below:

Figure 2 Balanced Line Video

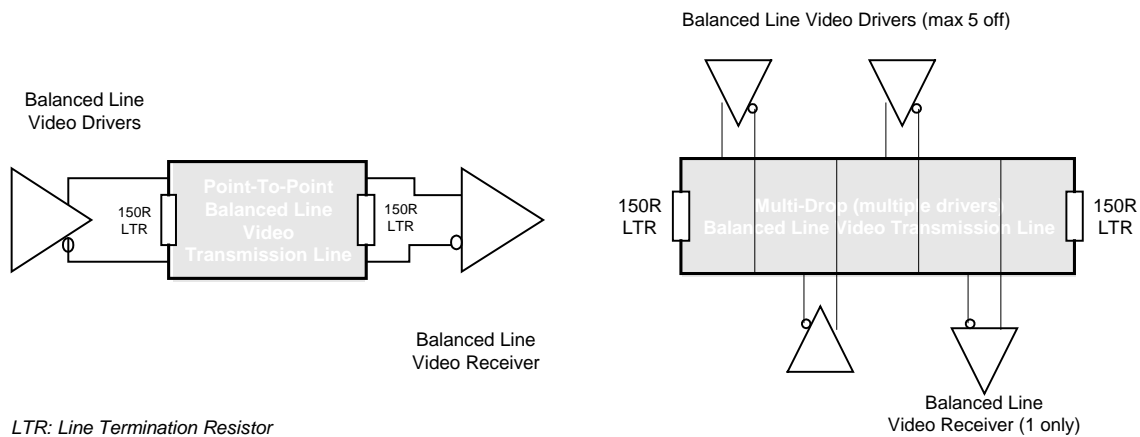

LTR: Line Termination Resistor

The intended transmission line is a single 150R twisted pair line terminated at both ends in its characteristic impedance (i.e. 150R line termination resistors fitted at both ends). Only certain detectors and video switchers have a multi-drop output capability, refer to the relevant technical manuals for details.

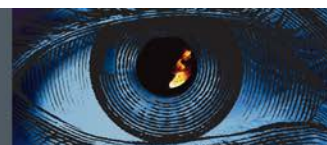



## 2 Safety Instructions

For the correct and effective use of this equipment, to maintain safety and avoid hazards it is essential that you read and understand these instructions and act accordingly BEFORE installing, operating or maintaining the equipment.

**PAY ATTENTION TO ALL SAFETY WARNINGS AND CAUTIONS**

### 2.1 Warnings

For UK installations BS/EN60079-14 'Electrical Installations in Hazardous Areas' and BS/EN60079-17 'Inspection and Maintenance in Hazardous Areas' should be strictly observed where the equipment is located within the hazardous area (a suitable certified enclosure is required).

For installations in North America the National Electrical Code (NEC) should be strictly observed.

Elsewhere the appropriate local or national regulation should be used.

The equipment must be properly earthed to protect against electrical shock and minimise electrical interference.

Repair of equipment should only be performed in a safe area and by trained personnel.

### 2.2 Cautions

Use only approved parts and accessories with this equipment.

To maintain safety standards, installation, commissioning and regular maintenance should be performed by qualified personnel.

### 2.3 Important Safety Notices

Pay attention to the guidelines given throughout this document

If in any doubt ask your local sales representative or contact Micropack (Engineering) Ltd.

Micropack (Engineering) Ltd take no responsibility for installation and/or use of its equipment if this is not in accordance with the appropriate issue and/or amendment of the manual.

Micropack (Engineering) Ltd reserve the right to change or revise the information contain herein without notice and without obligation to notify any person or organisation of such action.

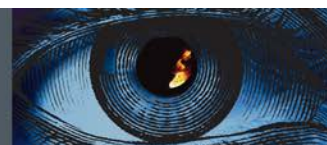



### 3 Installation

Experience has shown that poor installation and commissioning practice may result in poor video quality that is prone to malfunction.

#### 3.1 VTP4 Mounting

The VTP4 converter can be mounted in the following methods:

- Direct Chassis Mounting (using the four mounting points)
- DIN Rail Mounting (using the optional carrier)

In general the mounting arrangements should be free from vibration, movement or the potential for accidental knocking or forces acting on the connections and to be isolated as far as possible from the sources of local interference and allow ease of access to the equipment for maintenance and repair.

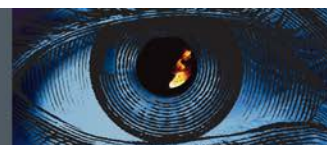
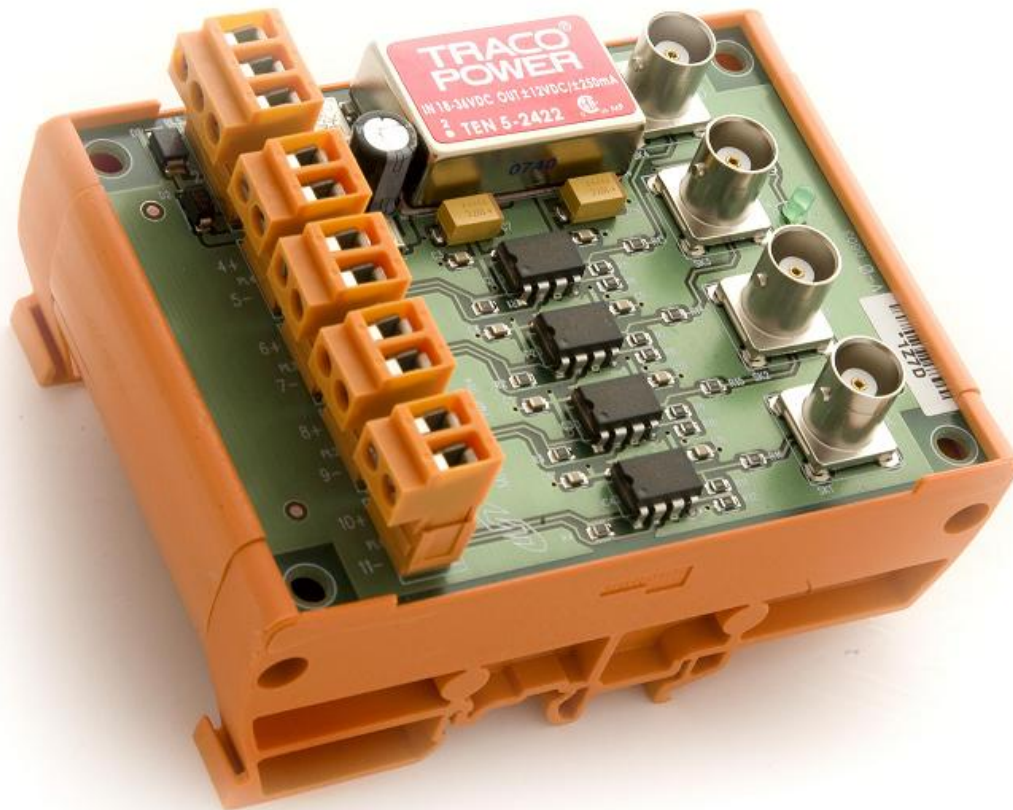



<b>VTP4 – Balanced Line To BNC Video Converter</b>		
<b>Ref 2200.5005</b>	<b>Rev: 3.0</b>	<b>Page 8 of 15</b>

### 3.2 Mechanical Installation

<b>Notes</b>	<p><b>Consideration should be given to cable entry with sufficient space for looming</b></p> <p><b>When locating the equipment consideration should be given to maintenance access and removal of the converter for repair or replacement</b></p> <p><b>The mounting should be secure and vibration free</b></p>
1	The electronics shall be protected form mechanical damage and external sources of EMI such as X-rays, RFI and electrostatic discharge
2	Mount the converter.

### 3.3 Field Terminations

There are 4 video channels available, these have the following function:

*Table 2 Terminal Descriptions*

Terminal	Input	Terminal	Output Signal
1	+24V Supply Input	N/A	N/A
2	0V Supply Input		
3	Do not connect		
4	Channel 1 +V Video Input	BNC1	Channel 1 75R Video Output
5	Channel 1 -V Video Input		
6	Channel 2 +V Video Input	BNC2	Channel 2 75R Video Output
7	Channel 2 -V Video Input		
8	Channel 3 +V Video Input	BNC3	Channel 3 75R Video Output
9	Channel 3 -V Video Input		
10	Channel 4 +V Video Input	BNC4	Channel 4 75R Video Output
11	Channel 4 -V Video Input		

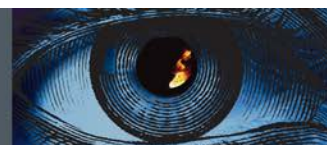





<b>VTP4 – Balanced Line To BNC Video Converter</b>		
<b>Ref 2200.5005</b>	<b>Rev: 3.0</b>	<b>Page 9 of 15</b>

### 3.4 Electrical Installation

The converter complies with the EMC requirements. In order to maintain compliance it is essential the electrical installation be engineered correctly.

<b>Notes</b>	<p><b>Video cabling must be segregated from cables carrying high-speed data or high energy and/or high frequency signals and other forms electrical interference</b></p> <p><b>The converter should only be fitted just prior to commissioning. Experience shows that the sensitive electronics can be damaged due to cable testing operations (Insulation tests, etc)</b></p>
1	Isolate all associated power supplies. Ensure that they remain OFF until required for commissioning
2	The electronics should be removed prior to installation. The electronics shall be protected from mechanical damage and external sources of EMI such as X-rays, RFI and electrostatic discharge
3	Prepare the cable tails. The cable screens and twisted pairs should ideally be maintained to within 1" (25mm) of the termination and insulated from contact with the enclosure or any other local earth.
4	Where plastic junction boxes are used the cable screens (shield) should be maintained to within 1" (25mm) of the termination and fully insulated
5	Where unscreened cables are used for panel wiring, then all cables must be suitably twisted into pairs and video cables should be segregated from other signal sources
6	All cable screens (shield) should be connected to the local clean earth at the control panel. The screens (and twisted pairs) should be maintained to within 1" (25mm) of the terminations
7	Following installation completion, the cabling shall undergo full earthing and insulation tests (with converter removed).

## 4 Maintenance and Testing

There are no specific maintenance requirements.

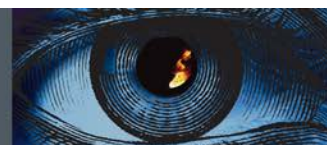



## 5 System Design Guidelines

### 5.1 Power Supply

The supply connects to terminal 1 for +24Vdc and terminal 2 for 0V. The system power supply voltage and power distribution should be arranged such that on the longest cable run the converter has a supply voltage of **greater** than 18V. To prevent video corruption the converter and all equipment connected to the coaxial outputs should share a common 0V supply, the volt drop on the 0V return must be kept to a minimum.

### 5.2 Balanced Line Video (twisted pair) Input

Connect the video twisted pair cable to one of the four video input connectors on the converter, observing the correct + and - video polarity. All devices on the video transmission line, whether drivers or receivers, should share a common 0V supply.

### 5.3 Video (Coaxial) Output

Connect the video coaxial cable to the one of the four BNC connectors on the converter. Care should be taken when connecting to commercial video equipment as the Video braid is often connected to the equipment 0V or earth. This can result in the supply current returning through the coaxial cable screen, which may affect the video quality or potentially cause an earth fault. In such cases care should be taken with the equipment power supply and cabling to reduce cable volt drop to a minimum.

### 5.4 Earthing & Screening Requirements

It is important to ensure that the system is correctly connected to earth. Incorrect or poor earthing can adversely affect system operation and may result in video corruption. The system 0V should be connected to a clean earth at only one point, generally this should be at the panel power supply (or 0V bus bar). Even small differences in earth potentials can cause an earth fault current to flow resulting in communication errors. Where this is not possible the system can either be connected to a local clean earth so long as the maximum potential difference between each earth does not exceed +/-7Vdc. Where earth fault monitoring is used care should be taken to ensure that the system 0V to earth potential is not exceeded. All video cable screens should be connected to the local clean earth at the control panel. The screens (and twisted pairs) should be maintained to within 1" (25.4mm) of the terminations at the relay driver, within all junction boxes and at the control panel. Where unscreened cables are used for panel wiring, then all cables must be suitably twisted into pairs and video cables should be segregated from other all signal sources.

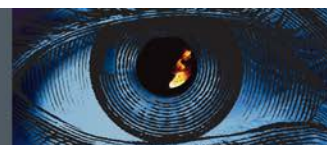



<b>VTP4 – Balanced Line To BNC Video Converter</b>		
<b>Ref 2200.5005</b>	<b>Rev: 3.0</b>	<b>Page 11 of 15</b>

## 5.5 Coaxial Video Cable Selection

The video cable should be low loss (attenuation) 75R coaxial cable with a stranded conductor to facilitate crimping, such as equivalent to RG59 or RG11, with the following characteristics:

Table 3 Video (Coaxial) Cable Characteristics

Cable Characteristic	Characteristic Impedance	Capacitance	Conductor Resistance	Attenuation @ 1MHz	Inductance
Nominal	75R	62pf/m	--	--	--
Absolute Limit	--	75pf/m	<150R	6db	--

The maximum cable length is determined by the cable manufacturer's attenuation specification, typically 300m, as shown in the calculation below. Coaxial video cabling generally produces the highest video quality and allows the use of commercial video switching equipment.

$$L_{km} = A_{db} \div A_{km}$$

Equation 1 Video (Coaxial) Cable Length Calculation

$A_{db}$	= Attenuation Limit (db)
$A_m$	= Cable Attenuation per Kilometre (db/km)
$L_{km}$	= Cable length in Kilometres

## 5.6 Balanced Line Video (Twisted Pair) Cable Selection

The video cabling should be a twisted pair stranded cable with an overall screen. Where multi-core cables are used then individual screened twisted pairs are recommended. The cable should have the following characteristics:

Table 4 Video (Twisted Pair) Cable Characteristics

Cable Characteristic	Characteristic Impedance	Capacitance	Conductor Resistance	Attenuation @ 1MHz	Inductance
Nominal	150R	50nf/Km	--	--	--
Absolute Limit	90R to 150R	100nf/Km	150R	6db	0.7mH/Km

The maximum cable length is dependent on the cable manufacturers attenuation specification, which is approximately proportional to conductor size. The characteristic impedance of a transmission line is a function of the physical dimensions of the conductor and the permittivity of the dielectric (the insulation), at high frequencies this is approximately equivalent to:

$$Z_o(\Omega) = \sqrt{L \div C}$$

Equation 2 Characteristic Impedence Calculation

$L$	= Cable Inductance (mH)
$C$	= Cable Capacitance (uF)
$Z_o$	= Characteristic Impedence (Ohms)

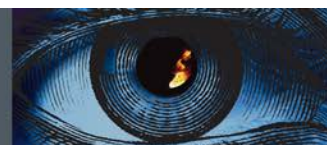



<b>VTP4 – Balanced Line To BNC Video Converter</b>		
<b>Ref 2200.5005</b>	<b>Rev: 3.0</b>	<b>Page 12 of 15</b>

## 6 Fault Finding

### 6.1 Live Video Images

The live video signal suffers more potential problems than for RS485 communications because the signal is an analogue transmission and available for operator scrutiny. The cabling is critical to video image quality. Due to the nature of the video signal video corruption will appear differently on each detector/installation. The following chart is intended as a guideline for diagnosis of video problems.

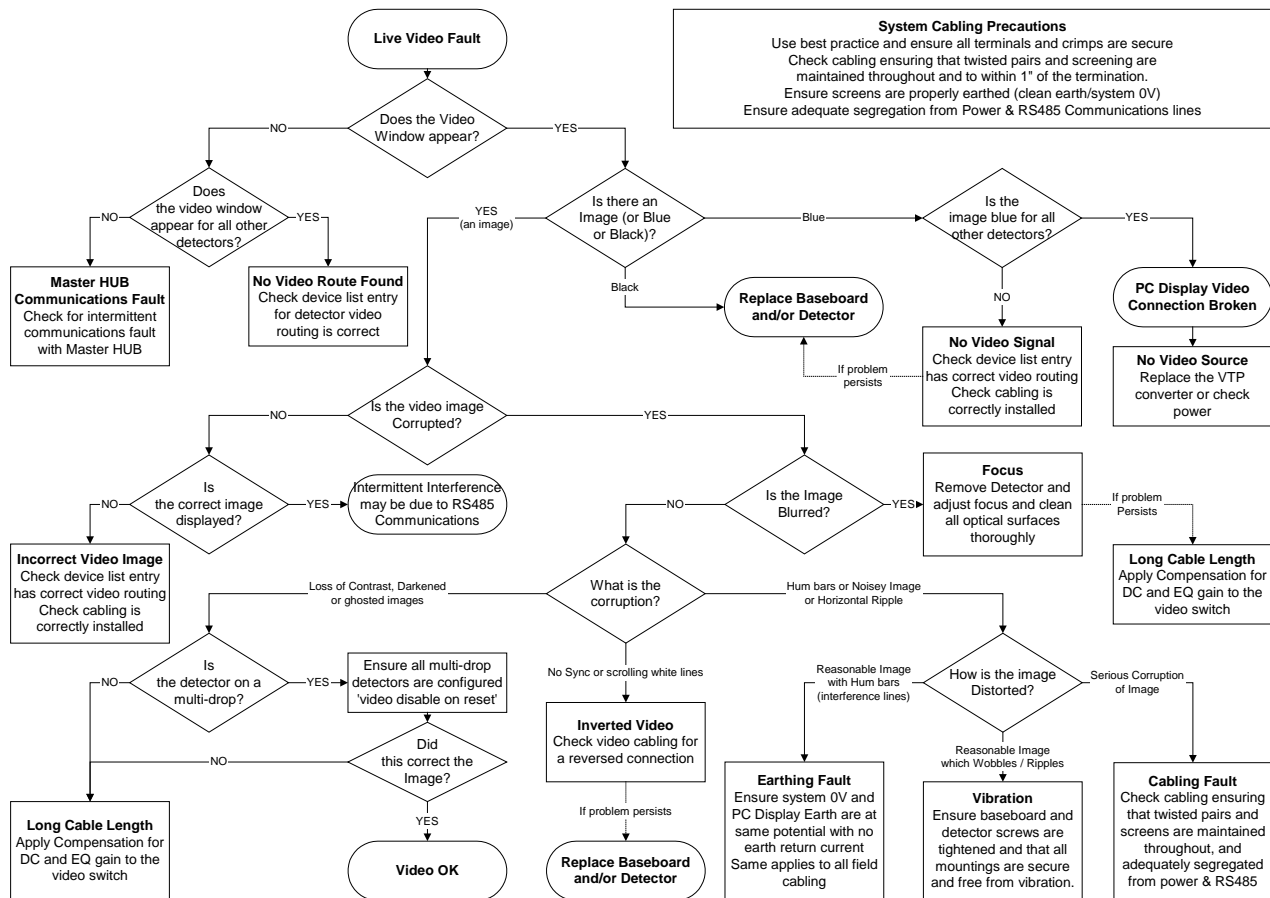
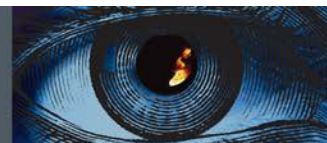

Figure 3 Video Signal Diagnostic Chart

### 6.2 Replacement and Repair

The converter contains no user serviceable parts, or hardware configuration links to set.





<b>VTP4 – Balanced Line To BNC Video Converter</b>		
<b>Ref 2200.5005</b>	<b>Rev: 3.0</b>	<b>Page 13 of 15</b>

## 7 Technical Specification

### 7.1 Electrical Specification

Parameter	Units	Min	Max	Comment
<b>Power Supply</b>				
Supply Voltage	V	18	32	Inc. ripple
Supply Ripple	V		1V	Peak to Peak
Power Consumption	W	1.5	5	
<b>Balanced Line Video Receiver</b>				
<b>150R Twisted Pair Cabling</b>				
Line Termination Resistor	R	--	150	Built into each I/P
Differential Input Voltage	V	--	2	Into 150R
Common Mode Input Range	V	-8	8	
<b>Coaxial Video Driver</b>				
<b>75R Coaxial Cabling</b>				
Line Termination Resistor	R	--	75	
Driver Output Resistance	R	--	75	
Driver Output Voltage (loaded)	V	--	1	Into 75R
Driver Fan Out	Unit loads	0	1	

### 7.2 Mechanical Specification

Parameter	Units	Min	Max
Overall Dimensions with DIN Rail Mounting	mm	108 Length x 78 width x 62 depth	
Board Dimensions without DIN Rail mounting	mm	100 Length x 70 width	
Shipping Weight	Kg	0.1	
Baseboard Terminal Entries	mm <sup>2</sup>	2.5	Maximum

### 7.3 Environmental Specification

Parameter	Units	Min	Max	Comment
Operating Ambient Temperature	°C	-20	+70	
Storage Ambient Temperature	°C	-20	+80	
Relative Humidity	% RH	5	95	Non Condensing

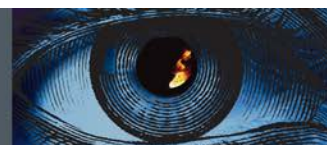



<b>VTP4 – Balanced Line To BNC Video Converter</b>		
<b>Ref 2200.5005</b>	<b>Rev: 3.0</b>	<b>Page 14 of 15</b>

## 7.4 Certification and Approvals

Parameter	Units
CE Certification	GEC: EN55022 & 082

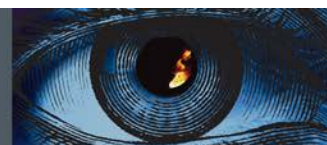



<b>VTP4 – Balanced Line To BNC Video Converter</b>		
<b>Ref 2200.5005</b>	<b>Rev: 3.0</b>	<b>Page 15 of 15</b>

## Appendix A – Help us to help you

<b>TO:</b> QA Department Micropack (Engineering) Limited Fire Training Centre Schoolhill, Portlethen AB12 4RR  Tel : +44 (0) 1224 784055 Fax : +44 (0) 1224 784056 Email : <a href="mailto:info@micropack.co.uk">info@micropack.co.uk</a>	<b>From:</b>   Tel : Fax : Email :
I suggest the following corrections/changes be made to Section .....	
Marked up copies attached (as appropriate): <span style="float: right;">Yes/No</span>	
Please inform me of the outcome of this change: <span style="float: right;">Yes/No</span>	
For Micropack (Engineering) Limited : Action by: _____ Date: _____ Response: _____ Date: _____	

